

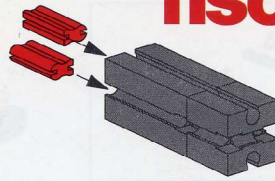

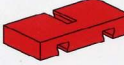





Trike

- 1**  1x  1x  15 2x

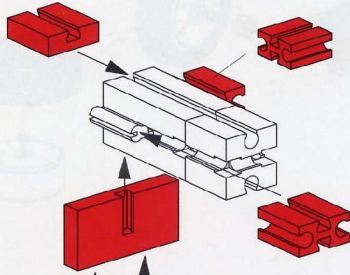

- 2**  1x  1x  2x  2x  2x



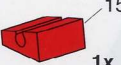

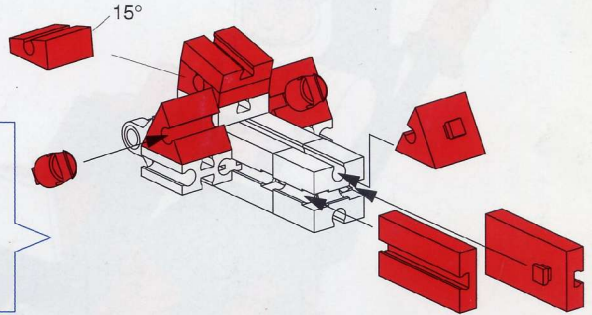

- 3**  60° 3x  2x  1x  2x  15° 1x

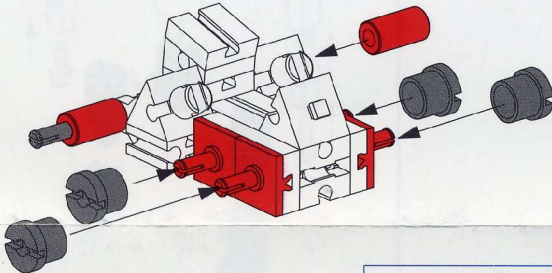





- 4**  80 1x  2x  4x  4x

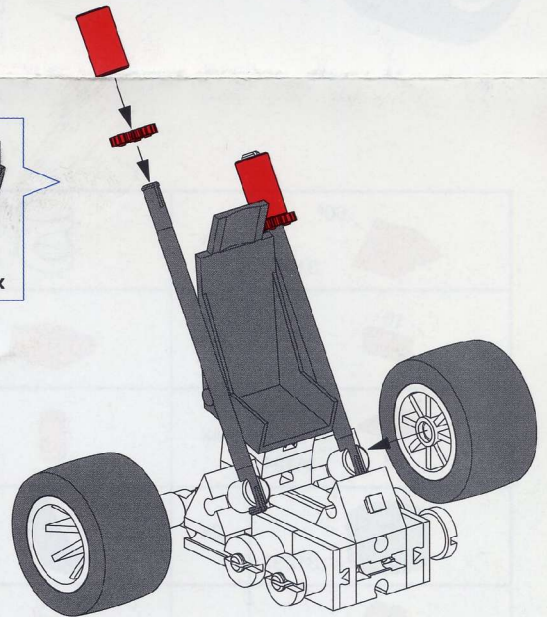





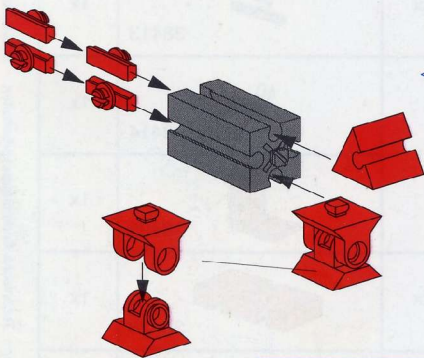

- 5**  80 2x  2x  2x  2x  1x



- 6**  1x  4x  60° 1x  1x  1x



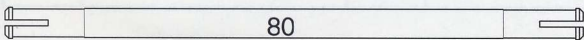
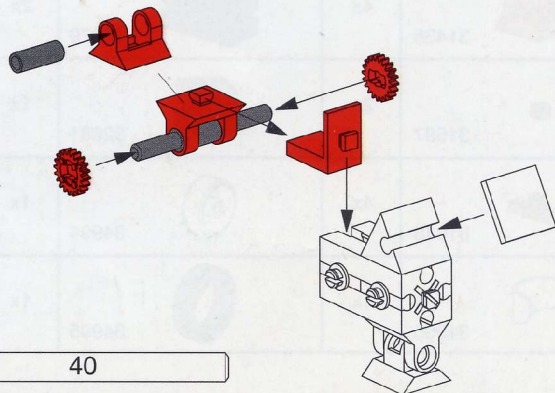

- 7**  1x  1x  1x  40 1x  2x  1x

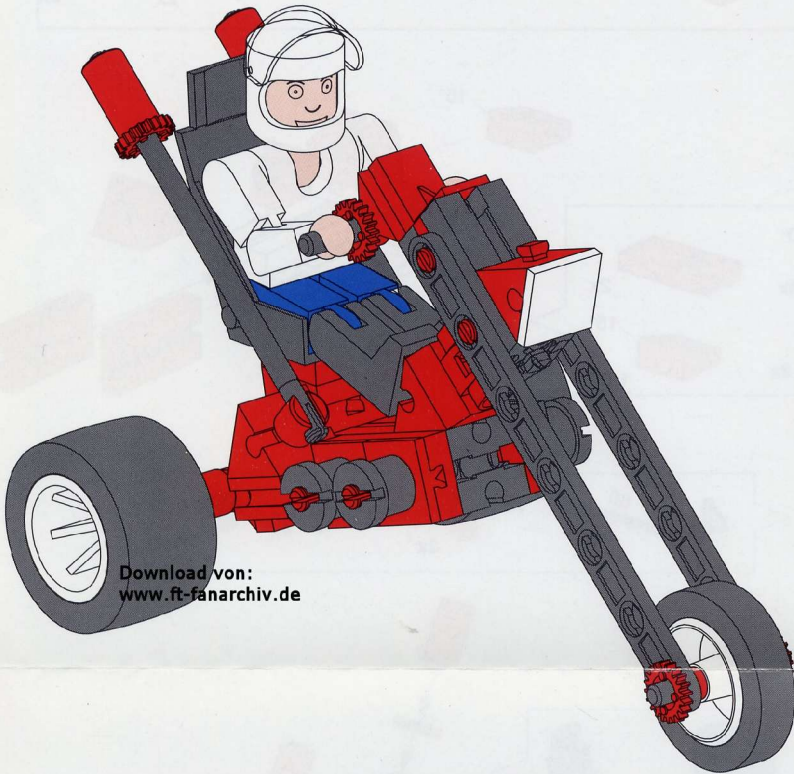
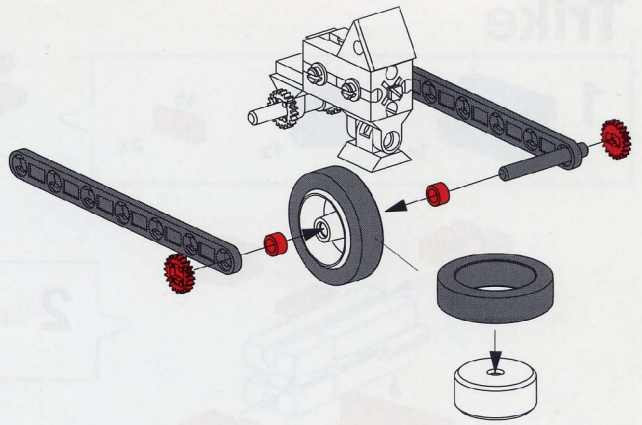
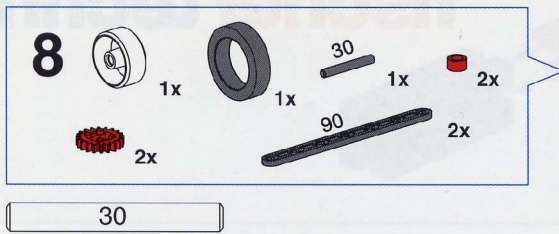

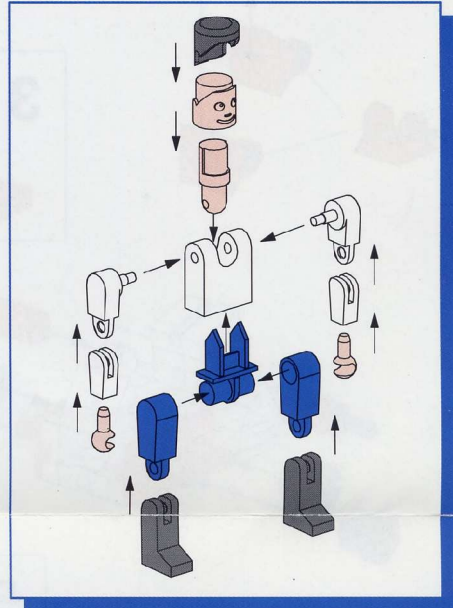

Download von:
www.ft-fanarchiv.de



 60° 31010	4x	 31909	1x	 35019	4x	 37468	2x
 15° 31060	2x	 15° 31981	1x	 35049	2x	 38263	1x
 31124	4x	 31983	4x	 80 35405	3x	 30 38413	1x
 31237	2x	 31984	1x	 35806	1x	 40 38414	1x
 31426	1x	 31987	2x			 38423	1x
 31436	4x	 32879	2x	 35980	2x	 38428	1x
 31597	2x	 32881	1x	 36334	6x	 90 38543	2x
 31848	4x	 34994	1x	 36819	3x		
 31905	1x	 34995	1x	 37237	2x		